

## TIME-FREQUENCY ANALYSIS OF THE AE SIGNALS GENERATED BY PDS ON BUSHING AND STAND-OFF INSULATORS

T. BOCZAR, S. BORUCKI, A. CICHÓN, M. LORENC

Opole University of Technology  
Faculty of Electrical Engineering, Automatic Control and Computer Science  
Sosnkowskiego 31, 45-272 Opole, Poland  
e-mail: tboczar@po.opole.pl

*(received June 15, 2006; accepted September 30, 2006)*

The subject matter of this paper refers to the application of the acoustic emission method (AE) for the measurement and analysis of the pulses (AE) generated by surface partial discharges (SPD) occurring on bushing and stand-off insulators. Within the research work carried out, the results of which are presented in this paper, the AE pulses generated by SPDs were measured at meteorological and technical parameter changes for high-voltage experiments carried out. The range of the research work included the comparison of the time-frequency analysis results of the AE pulses generated by SPDs in a bushing insulator at the distance changes between an insulation grip and a ferrule, and at the internal electrode diameter changes. In Summing-up the comparative analysis was carried out for the results obtained in the time-frequency domain for bushing and stand-off insulators.

**Key words:** partial discharges (PDs), acoustic emission (AE), surface discharges (SPDs), stand-off insulator, bushing insulator.

### 1. Introduction

At present the acoustic emission method (AE) constitutes a significant supplement of the measuring methods used in diagnostics of insulation systems of power appliances. It enables taking measurements in industrial conditions without shutting down the power system of the appliances being in operation. The information obtained through using the AE method refers to the size, intensity, and to a limited extent, location of partial discharge (PD) occurrence in insulation systems under study.

In operation practice there exists a big number of insulation systems constructed in such a way that solid dielectrics co-operate with liquid and gas dielectrics. The plane dividing the co-operating dielectrics is usually the place in which electric strength of the whole system is the smallest. Surface electrical partial or disruptive discharges, leading to insulation breakdown, can occur along this surface. The formation and development of surface partial discharges (SPDs) depends mainly on the type and condition of the solid dielectric surface, type of the voltage supplying a system and spatial distribution of

electric field intensity. The resistance of a solid dielectric to PD formation on its surface is also significant. These properties are conditioned by the internal structure of a solid dielectric, and, first of all, by the presence of a dirt layer on its surface. Dielectrics such as glass or porcelain, contrary to dielectrics of the organic origin, do not participate actively in PD formation and development.

A bushing insulator is a classic example of a diagonally layered system. Voltage distribution in such an insulation system depends, first of all, on the surface capacity and dielectric capacity placed between the electrodes. A stand-off insulator, however, is the simplest example of a parallel layered insulation system, in which electric field intensity has the same value on both sides of border surfaces in each dielectric. At the same electric field intensity the electric spark-over occurs in the dielectric of a lower strength. Equivalent circuit diagrams of such systems, equations describing physics of the phenomena analyzed and diagrams showing the dependence of sparking voltage on the distance between the electrodes have been widely discussed, among others, in works [8, 9].

The aim of the research work carried out, the results of which are presented in this paper, was registering and carrying out the time-frequency analysis, with stress on continuous and discrete wavelet transforms of the AE pulses generated by PDs on bushing and stand-off insulators. For that purpose a model system in the form of a porcelain insulator was used, a simplified diagram of which is shown in Fig. 1. In previous research work, the results of which are presented in paper [4], the influence of geometric parameters of the system modeling a bushing insulator on the frequency analysis results of the AE pulses generated was determined. It was observed that the results obtained in the frequency domain are not influenced by:

- distance changes between a metal grip (2) to which high voltage was connected and a grounded ferrule (3) of the porcelain insulation pipe (4) in the range from 2 cm to 10 cm,
- changes of the metal insert thickness (1) for a bushing insulator in the diameter range ( $d$ ) from 4.9 mm to 11.9 mm, at a constant electrode distance ( $a$ ).

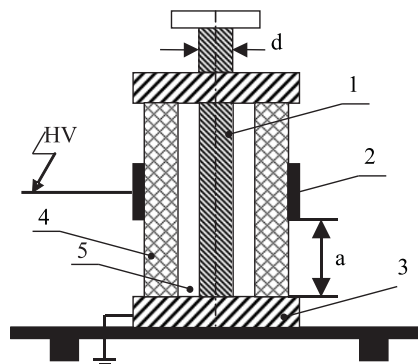

Fig. 1. Idea diagram of the system modeling bushing and stand-off insulators; 1 – metal insert, 2 – movable grip, 3 – grounded ferrule, 4 – porcelain insulation, 5 – transformer oil.

The research work carried out presently, presented in this paper, refers to the comparative analysis of the time-frequency analysis results obtained for the system modeling PDs in a stand-off insulator (without a metal insert –1) and in a bushing insulator.

The measurements of the AE pulses generated by PDs were taken at the same relative voltage value equal to  $0.8 U_p$  (breakdown voltage of the system) so that the results obtained could be subjected to the comparative analysis. The model systems constructed were supplied from a test transformer, which enabled fluent adjustment of the supplying alternating voltage in the range from 0 to 220 kV. The AE pulses generated by PDs were registered by using a measuring system by the Brüel & Kjær firm, the detailed characteristics of which has been presented in works [1, 5–7]. The AE pulses measured were subject to the time-frequency analysis consisting in determining a continuous and discrete wavelet transform and a short-time Fourier transform, using mathematical dependences characterized, among others, in works [2, 3, 5–7]. Moreover, the results obtained were supplemented with power density spectra, power diagrams and the autocovariance function.

## 2. The results of the time-frequency analysis of the AE pulses generated by PDs in bushing and stand-off

Repeatable, characteristic shapes of spectrogram, scaling graphs and wavelet decomposition runs were obtained for the measurements taken of the AE pulses generated by PDs in systems modeling bushing and stand-off insulators.

Analyzing the time-frequency analysis results obtained it was observed that the polarization of the voltage supplying the systems under study does not influence the shape

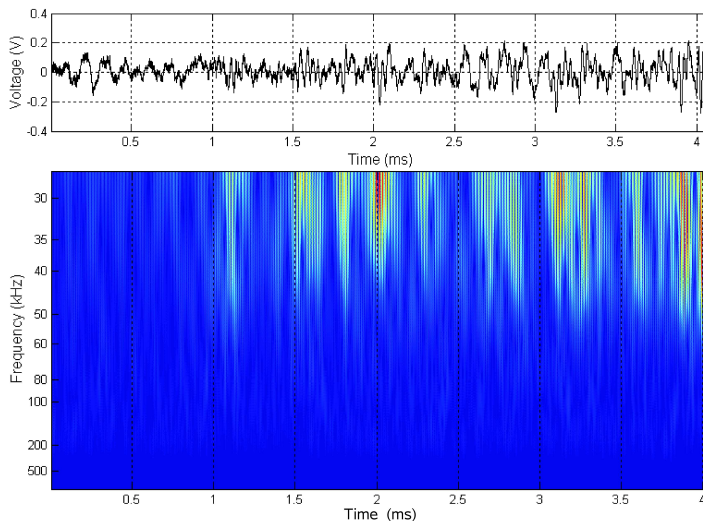

Fig. 2. CWT scaling graph of the AE pulses generated by PDs in a bushing insulator at the positive voltage polarization. The distance between the grip and the ferrule is 10 cm and the insert diameter 11.9 mm.

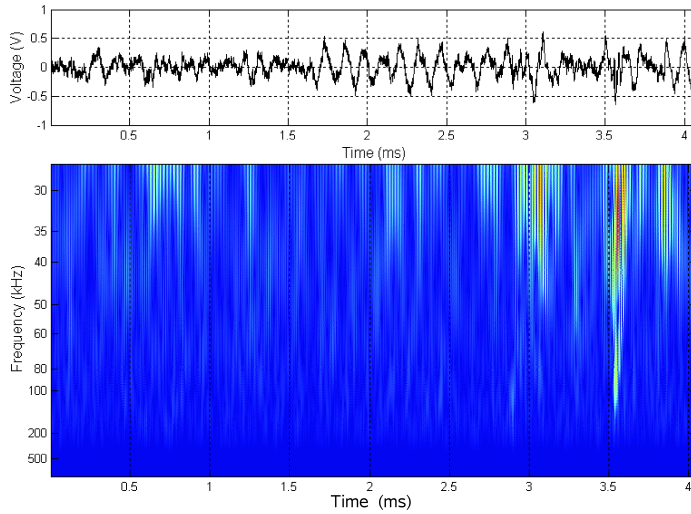

Fig. 3. CWT scaling graph of the AE pulses generated by PDs in a stand-off insulator at the positive voltage polarization. The distance between the grip and the ferrule is 10 cm.

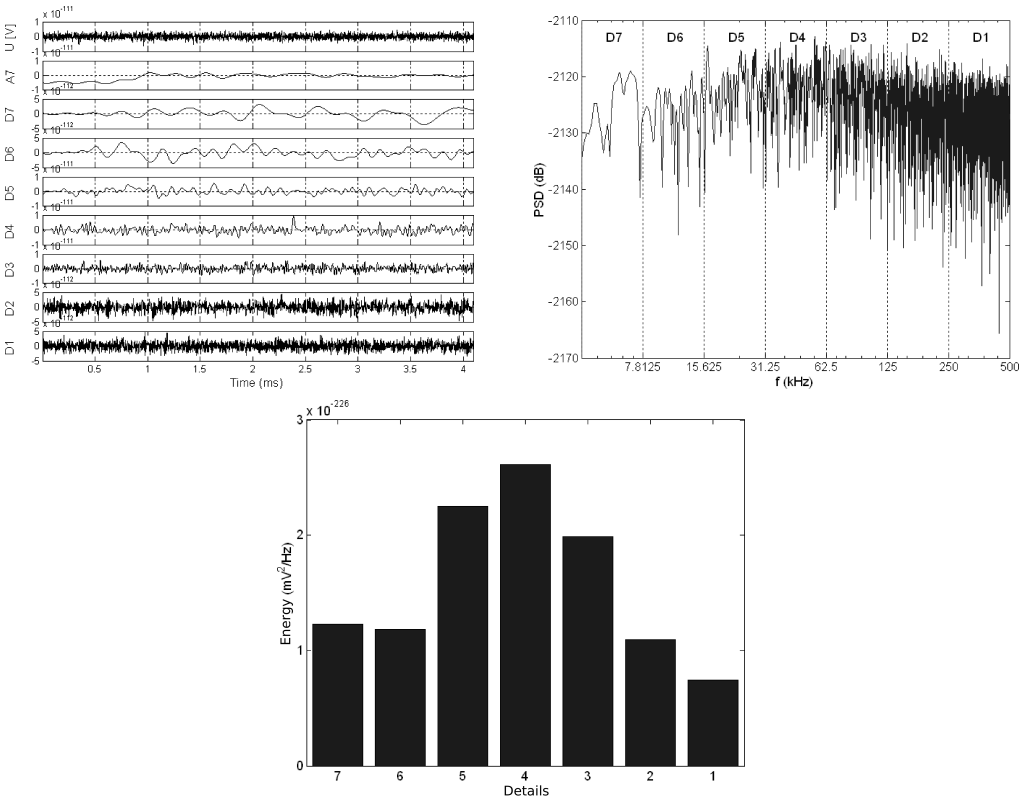

Fig. 4. DWT, PSD and power diagrams scaling graph of the AE pulses generated by PDs in a bushing insulator at the positive voltage polarization. The distance between the grip and the ferrule is 10 cm and the insert diameter 11.9 mm.

and character of the runs obtained. Minimum value of the mutual correlation coefficient, determined comparatively for the positive and negative half-time of the supplying voltage, spectrograms, scaling graphs and wavelet decomposition runs was bigger than 0.95.

Hence Figs. 2–7 show only the runs of scaling graphs (Figs. 2, 3), wavelet decomposition runs supplemented with power density spectra and power diagrams (Figs. 4, 5) and two- and three-dimensional spectrograms (Figs. 6, 7), which were determined for the AE pulses generated by PDs at the positive voltage polarization for the system modeling a bushing insulator (Figs. 2, 4, 6) and a stand-off insulator (Figs. 3, 5, 7).

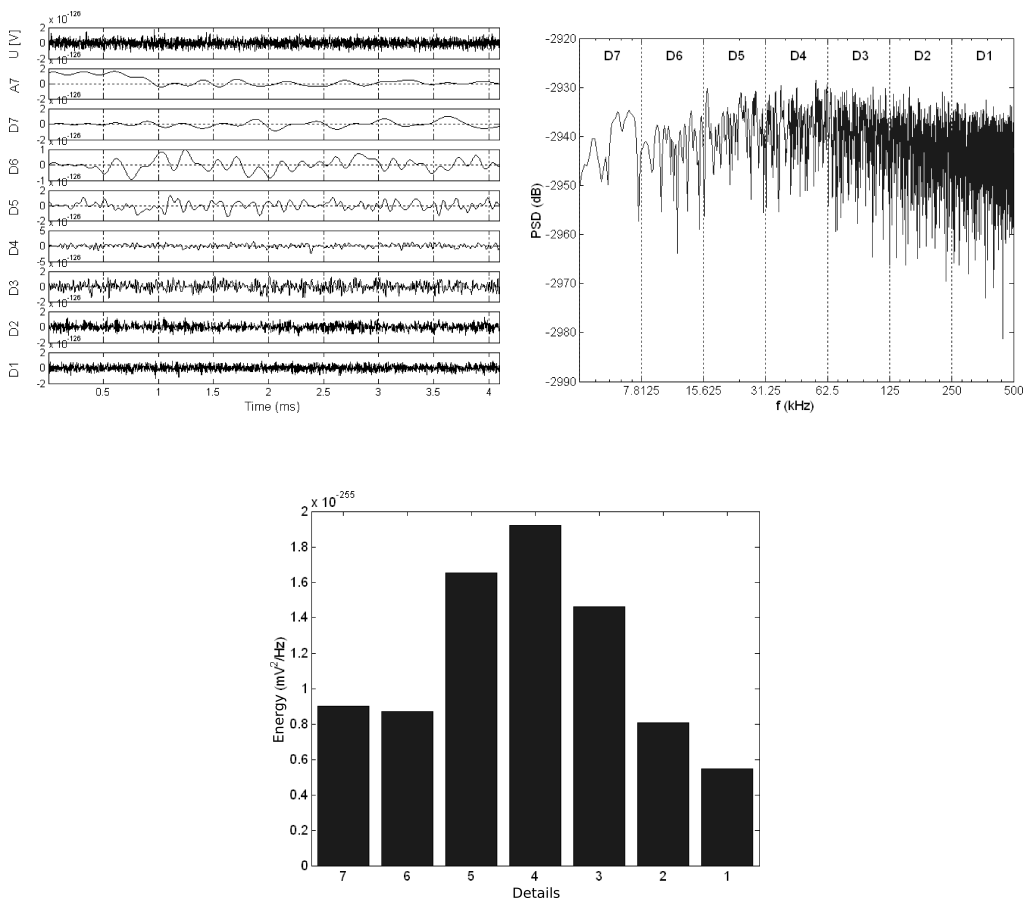

Fig. 5. DWT, PSD DWT, PSD and power diagrams scaling graph of the AE pulses generated by PDs in a stand-off insulator at the positive voltage polarization. The distance between the grip and the ferrule is 10 cm.

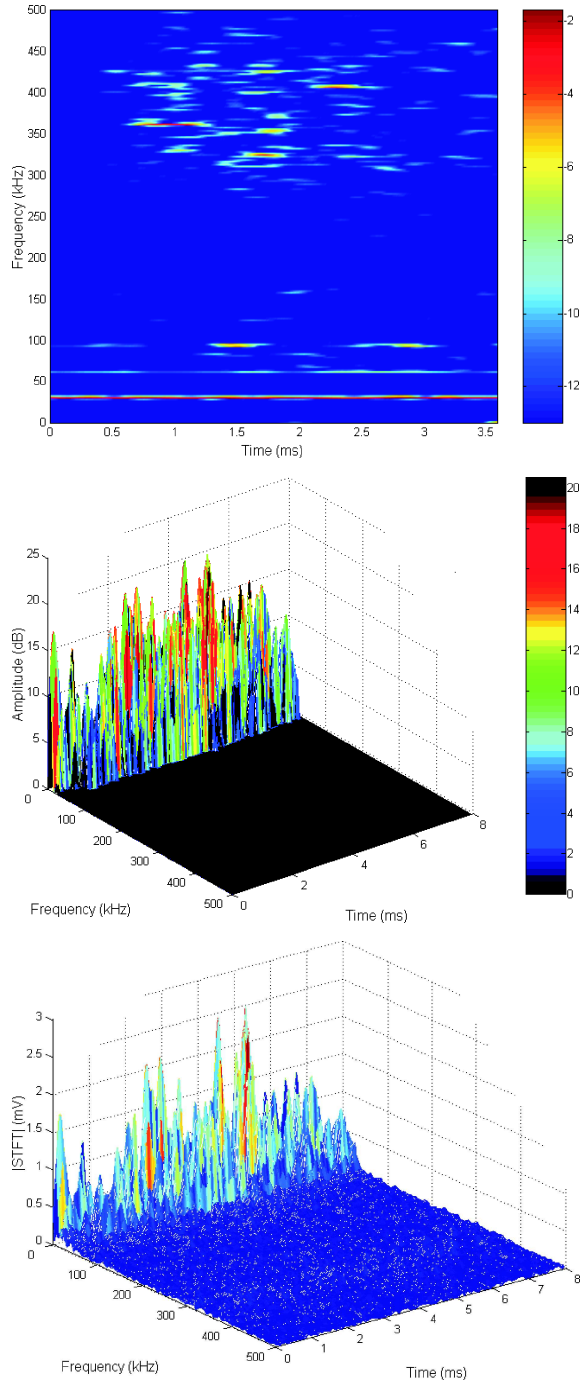

Fig. 6. Spectrogram, three-dimensional spectrogram of amplitude spectrum, three-dimensional spectrogram of power spectrum density scaling graph of the AE pulses generated by PDs in a stand-off insulator at the positive voltage polarization. The distance between the grip and the ferrule is 10 cm.

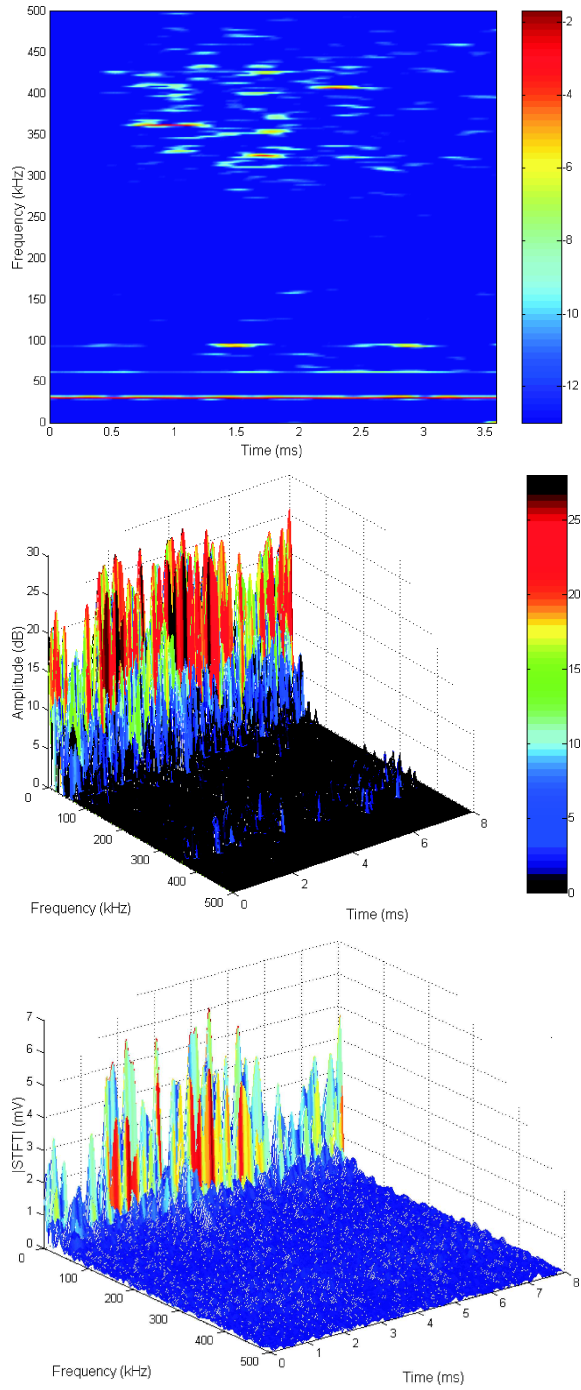

Fig. 7. Spectrogram, three-dimensional spectrogram of amplitude spectrum, three-dimensional spectrogram of power spectrum density scaling graph of the AE pulses generated by PDs in a stand-off insulator at the positive voltage polarization. The distance between the grip and the ferrule is 10 cm.

### 3. Comparative analysis of the results obtained

Based on the results of the time-frequency analyses carried out of the measured AE pulses generated by PDs the following conclusions can be drawn:

- based on the runs of CWT scaling graphs it can be observed that the band of dominant frequencies for bushing insulators is in the range (0–80) kHz, and for the stand-off insulator it is wider and contained in the range (0–200) kHz,
- on spectrograms determined by using STFT, compared with wavelet images obtained for scaling graphs, there can be observed additional ranges of dominant frequencies in the range from 300 to 450 kHz, which can be observed for the two insulator types under study, and the electric participation of the structures presented is more significant for the AE pulses generated by PDs on the stand-off insulator,
- based on the wavelet decomposition runs it can be observed that both for the AE pulses generated by PDs on the stand-off and bushing insulators the same power structure for the particular decomposition levels was obtained. Details D3–D5 have the biggest power participation, which corresponds with the frequency range (46.8–187.5) kHz. The participation of the other details is at similar level, but the energy size is of more than 30% smaller than that of dominant details.

The results obtained confirm the necessity of taking into account PDs generated on stand-off and bushing insulators during diagnostic measurements of insulation systems of power transformers. This can be of a vital importance for the correct interpretation of the measurement results obtained on-line of the AE generated by PDs. Moreover, obtaining varied results for the insulator types under study can be useful for recognizing PDs measured by the AE method for insulators of appliance operating in power appliances.

#### Acknowledgments

The research work is co-financed from the resources of the European Social Fund and the state budget means.

#### References

- [1] BOCZAR T., *Identification of a specific type of partial discharges form acoustic emission frequency spectra*, IEEE Transactions on Dielectrics and Electrical Insulation, **8**, 4, 598–606 (2001).
- [2] BOCZAR T., *Możliwości zastosowania do opisu sygnałów emisji akustycznej od wylądowań niezupelných analizy statystycznej i cyfrowych metod przetwarzania sygnałów*, Studia i Monografie, Of. Wyd. Pol. Op., z. 146, Opole 2003.
- [3] BOCZAR T., *Obiektywizacja wyników akustycznej metody oceny wylądowań niezupelných przy zastosowaniu do opisu sygnałów analizy statystycznej i cyfrowych metod przetwarzania*, Studia i Monografie, Of. Wyd. Pol. Op., z. 147, Opole 2003.
- [4] BOCZAR T., FRĄCZ P., *Emisja akustyczna wylądowań niezupelných generowanych na izolatorach przepustowych i wsporczych*, Zeszyt Specjalny Przeglądu Elektrotechnicznego, VI Ogólnopolskie Sympozjum Inżynieria Wysokich Napięć IW 2002, pp. 22–26, Poznań – Kiekrz, 20-22.05.2002.



- 
- [5] BOCZAR T., ZMARZŁY D., *Application of the short time Fourier transform in evaluation of the acoustic emission signals generated by partial discharges*, The Molecular and Quantum Acoustics Journal, **25**, 45–68 (2004).
  - [6] BOCZAR T., ZMARZŁY D., *Application of wavelet analysis to acoustic emission pulses generated by partial discharges*, IEEE Transactions on Dielectrics and Electrical Insulation, **11**, 3, 433–449 (2004).
  - [7] BOCZAR T., ZMARZŁY D., *Multiresolution analysis of the acoustic emission pulses generated by partial discharges*, INSIGHT – The Journal of the British Institute of Non-Destructive Testing, **45**, 7, 488–492 (2003).
  - [8] FLISOWSKI Z., *Technika wysokich napięć*, WNT, Warszawa 1995.
  - [9] SZCZEPAŃSKI Z., *Wytrzymałość dielektryczna*, Skrypt Pol. Łódzka, 1986.